

NU

Neuro Instruments

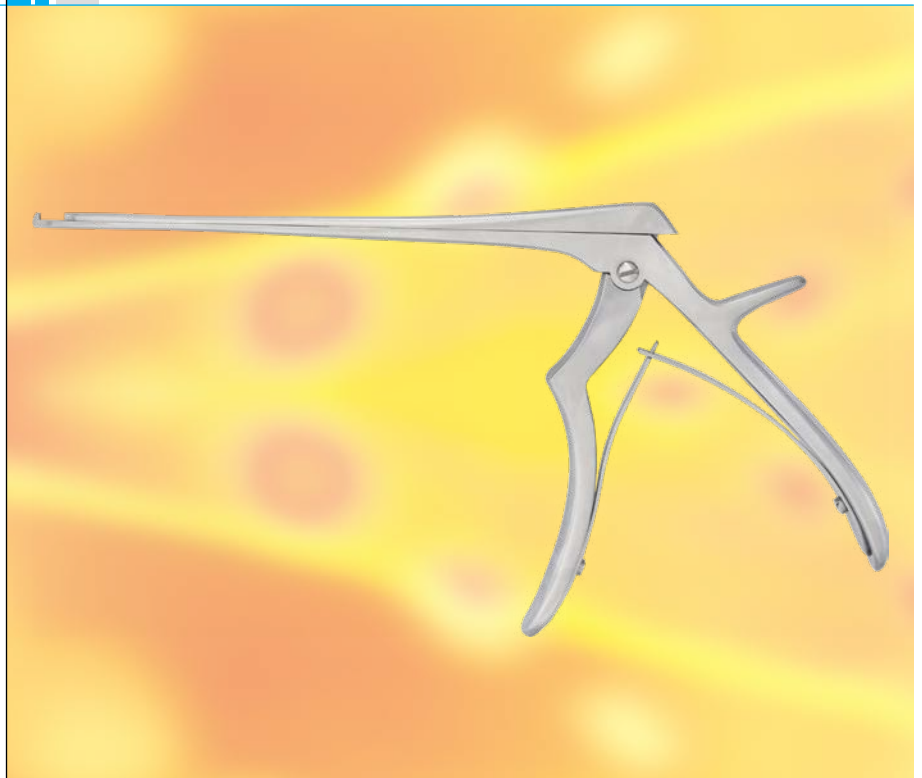



Wire saws

GIGLI

- 30 cm/11" **NU.600.30**
- 40 cm/16" **NU.600.40**
- 50 cm/20" **NU.600.50**
- 60 cm/24" **NU.600.60**
- 70 cm/28" **NU.600.70**



Wire saw handle

GIGLI
NU.602.01

Wire saw guide



DE MARTEL
NU.618.33
33 cm/13"



Medium pattern

CRUTCHFIELD
NU.641.02

Drill point
Ø 3.5 mm



NU.641.04
7 cm/2¾"

Ø 5 mm



NU.641.05
7 cm/2¾"



GARDNER-WELLS
NU.641.00

Maksimum açıklık (16 cm)
Maximum opening (16 cm)

NU.641.01
Small pattern



CRUTCHFIELD

NU.643.01
Large pattern



NU.643.10

Spare pin for
32-7643-01



with 3 hooks



DAHLGREN
NU.654.20
19.5 cm/7¾"

with 2 hooks



DE VILBISS
NU.658.21
21 cm/8¼"

Cranial Punch



CONE
NU.659.22
22.5 cm/8¾"

Clip Applying Forceps



MCKENZIE
NU.663.19
18.5 cm/7¼"



RANEY
NU.676.00
15.5 cm/6"

Clip Applying Forceps



OLIVECRONA-TOENNIS
NU.661.14

Galea hook



YASARGIL

30 cm/11" **NU.678.01**
41 cm/16¼" **NU.678.02**



TOENNIS
NU.680.25
24 cm/9½"



OLIVECRONA
NU.681.24
24 cm/9½"



OLIVECRONA
NU.682.18
18 cm/7"



OLIVECRONA
NU.683.24
24 cm/9½"



OLIVECRONA
NU.684.19
20 cm/8"



SACHS
NU.685.21
20.5 cm/8¼"



MILLIGAN
NU.686.21
22 cm/8¾"

Fig. 1



PENFIELD
NU.690.01
17.5 cm/7"

Fig. 2



PENFIELD
NU.690.02
19.5 cm/7¾"

Fig. 3



PENFIELD
NU.690.03
19.5 cm/7¾"

Fig. 4



PENFIELD
NU.690.04
20.5 cm/8"

Fig. 5



PENFIELD
NU.690.05
18.5 cm/7¼"



NU.688.22
22 cm/8¾"



DAVIS
NU.687.21
21.5 cm/8½"



DAVIS
NU.691.24
24.5 cm/9¾"

Fig. 1



CUSHING
19 cm/7½"
28 cm/11"



Fig. 2

Fig. 1
NU.742.19
NU.742.28

Fig. 2
NU.744.19
NU.744.28



ADSON
20 cm/8"

blunt



NU.823.20

sharp



NU.824.20



GRAHAM
NU.825.16
16.5 cm/6½"



SACHS
NU.827.18
17 cm/6¾"



GRONINGEN
NU.738.26
26.5 cm/10½"



GRONINGEN
NU.740.26
26.5 cm/10½"



SMITHWICK
16.5 cm/6½"
21 cm/8¼"
NU.748.17
NU.748.21



NU.830.19



NU.831.19

19 cm/7½"



FRAZIER
13 cm/5"
18 cm/7"
NU.835.13
NU.835.18

Tumor fork

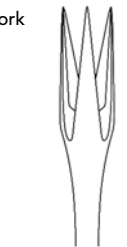











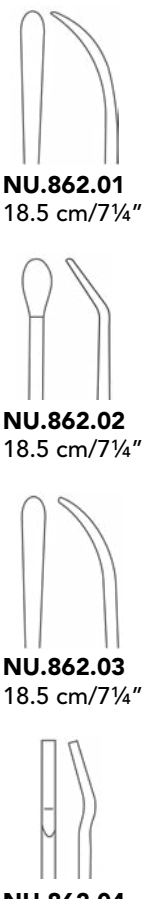

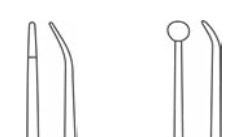
NU.853.01
8 mm



NU.853.02
5 mm

YASARGIL
20 cm/8"

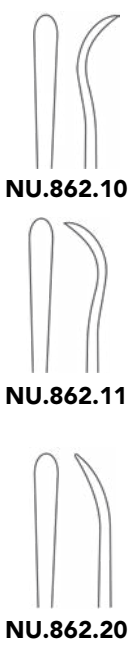
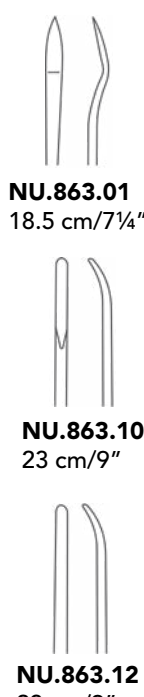
<p>Tissue claw</p>  <p>NU.853.03 18.5 cm/7"</p>	<p>Suture guide</p> <p>90°</p>  <p>YASARGIL 18.5 cm/7¼"</p>	<p>Micro raspatory</p>  <p>YASARGIL</p>	 <p>NU.862.01 18.5 cm/7¼"</p> <p>NU.862.02 18.5 cm/7¼"</p> <p>NU.862.03 18.5 cm/7¼"</p> <p>NU.862.04 18.5 cm/7¼"</p>	 <p>NU.862.05 23 cm/9"</p> <p>NU.862.06 23 cm/9"</p> <p>NU.862.07 23 cm/9"</p>	<p>Tumor knife</p>  <p>SAMII 23 cm/9"</p>	 <table border="0"> <tr> <td>1.0 mm</td> <td>NU.854.01</td> <td></td> </tr> <tr> <td>1.5 mm</td> <td>NU.854.02</td> <td>NU.854.09</td> </tr> <tr> <td>2.0 mm</td> <td>NU.854.03</td> <td></td> </tr> <tr> <td>2.5 mm</td> <td>NU.854.04</td> <td></td> </tr> <tr> <td>3.0 mm</td> <td>NU.854.05</td> <td>NU.854.10</td> </tr> <tr> <td>3.5 mm</td> <td>NU.854.06</td> <td></td> </tr> <tr> <td>4.0 mm</td> <td>NU.854.07</td> <td></td> </tr> <tr> <td>4.5 mm</td> <td></td> <td>NU.854.11</td> </tr> <tr> <td>5.0 mm</td> <td>NU.854.08</td> <td></td> </tr> <tr> <td>6.0 mm</td> <td></td> <td>NU.854.12</td> </tr> </table>	1.0 mm	NU.854.01		1.5 mm	NU.854.02	NU.854.09	2.0 mm	NU.854.03		2.5 mm	NU.854.04		3.0 mm	NU.854.05	NU.854.10	3.5 mm	NU.854.06		4.0 mm	NU.854.07		4.5 mm		NU.854.11	5.0 mm	NU.854.08		6.0 mm		NU.854.12
1.0 mm	NU.854.01																																			
1.5 mm	NU.854.02	NU.854.09																																		
2.0 mm	NU.854.03																																			
2.5 mm	NU.854.04																																			
3.0 mm	NU.854.05	NU.854.10																																		
3.5 mm	NU.854.06																																			
4.0 mm	NU.854.07																																			
4.5 mm		NU.854.11																																		
5.0 mm	NU.854.08																																			
6.0 mm		NU.854.12																																		

<p>Micro raspatory bayonet</p>  <p>YASARGIL 18.5 cm/7¼"</p>	<p>Micro dissector straight</p>  <p>YASARGIL</p>	<p>Micro dissector bayonet</p>  <p>YASARGIL 23 cm/9"</p>	<p>Buttoned probe</p>  <p>JACOBSON NU.864.02 18.5 cm/7¼"</p>	<p>Probe double</p>  <p>JACOBSON NU.864.01 18.5 cm/7¼"</p>	<p>Micro curette</p>  <p>YASARGIL NU.865.01 18.5 cm/7¼"</p>
 <p>NU.862.10</p> <p>NU.862.11</p> <p>NU.862.20</p>	 <p>NU.863.01 18.5 cm/7¼"</p> <p>NU.863.10 23 cm/9"</p> <p>NU.863.12 23 cm/9"</p>	 <p>NU.863.11</p> <p>NU.863.13</p>			



Micro curette



YASARGIL
23 cm/9"

Dura hook



YASARGIL
23 cm/9"

Micro hooklet

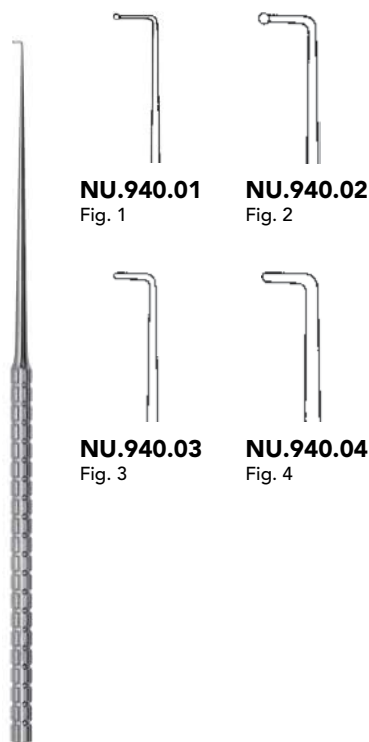

KRAYENBUEHL
19 cm/7½"

Micro dissector



CASPER

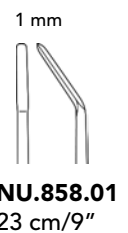

JACOBSON
NU.858.01
23 cm/9"

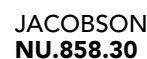

JACOBSON
NU.858.30

SAMII

Bayonet

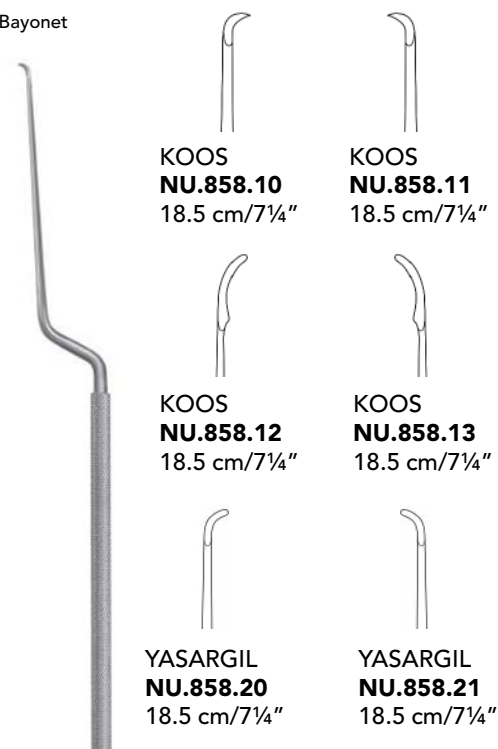

KOOS
NU.858.10
18.5 cm/7¼"

KOOS
NU.858.11
18.5 cm/7¼"

KOOS
NU.858.12
18.5 cm/7¼"

KOOS
NU.858.13
18.5 cm/7¼"

YASARGIL
NU.858.20
18.5 cm/7¼"

YASARGIL
NU.858.21
18.5 cm/7¼"

Micro vascular knife

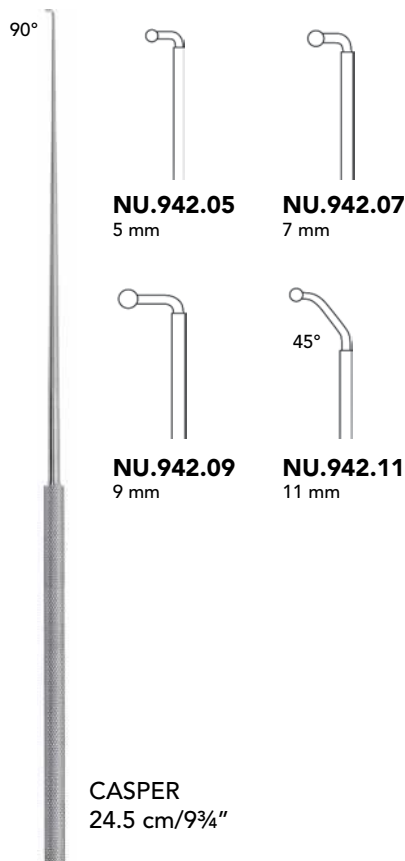

NU.942.05
5 mm

NU.942.07
7 mm

NU.942.09
9 mm

NU.942.11
11 mm

CASPER
24.5 cm/9¾"

bayonet

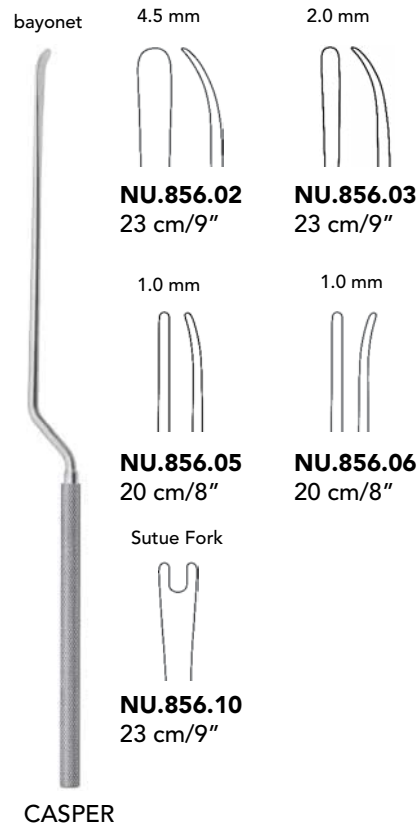

NU.856.02
23 cm/9"

NU.856.03
23 cm/9"

NU.856.05
20 cm/8"

NU.856.06
20 cm/8"

NU.856.10
23 cm/9"

CASPER



INGE
NU.977.27
25.5 cm/10"



CLOWARD
NU.973.15

Tam açıklık/Total opening 4.5 cm
13.5 cm



CLOWARD
NU.973.16
16 cm/6¼"



INGE
NU.975.17
16 cm/6¼"



CLOWARD
NU.974.17
16 cm/6¼"

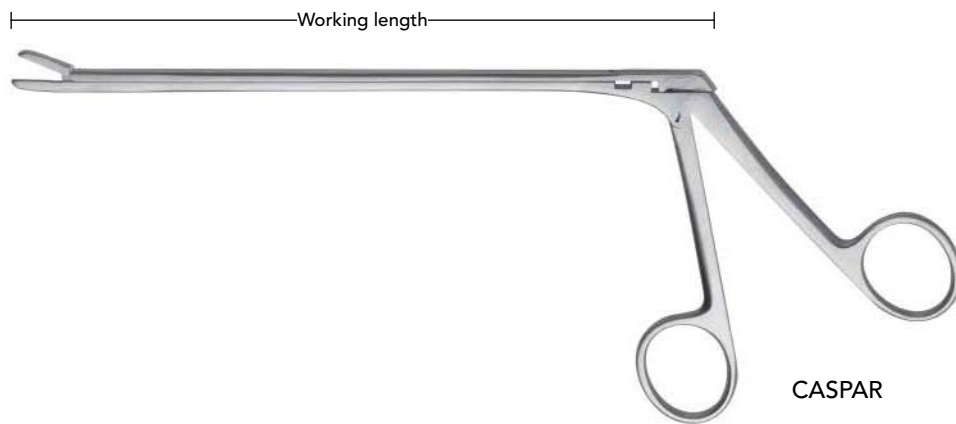

CASPAR

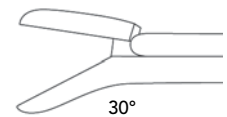
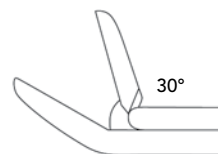
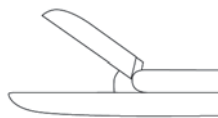

2 mm	Working length						
	15 cm/6"	NU.981.05	NU.482.05	NU.981.25	NU.482.25	NU.981.45	NU.482.45
	18 cm/7"	NU.981.09	NU.482.09	NU.981.29	NU.482.29	NU.981.49	NU.482.49
	20 cm/8"	NU.981.13	NU.482.13	NU.981.33	NU.482.33	NU.981.53	NU.482.53
	30 cm/11¾"	NU.981.17	NU.482.17	NU.981.37	NU.482.37	NU.981.57	NU.482.57

3 mm	Working length						
	15 cm/6"	NU.981.06	NU.482.06	NU.981.26	NU.482.26	NU.981.46	NU.482.46
	18 cm/7"	NU.981.10	NU.482.10	NU.981.30	NU.482.30	NU.981.50	NU.482.50
	20 cm/8"	NU.981.14	NU.482.14	NU.981.34	NU.482.34	NU.981.54	NU.482.54
	30 cm/11¾"	NU.981.18	NU.482.18	NU.981.38	NU.482.38	NU.981.58	NU.482.58

4 mm	Working length						
	15 cm/6"	NU.981.07	NU.482.07	NU.981.27	NU.482.27	NU.981.47	NU.482.47
	18 cm/7"	NU.981.11	NU.482.11	NU.981.31	NU.482.31	NU.981.51	NU.482.51
	20 cm/8"	NU.981.15	NU.482.15	NU.981.35	NU.482.35	NU.981.55	NU.482.55
	30 cm/11¾"	NU.981.19	NU.482.19	NU.981.39	NU.482.39	NU.981.59	NU.482.59

5 mm	Working length						
	15 cm/6"	NU.981.08	NU.482.08	NU.981.28	NU.482.28	NU.981.48	NU.482.48
	18 cm/7"	NU.981.12	NU.482.12	NU.981.32	NU.482.32	NU.981.52	NU.482.52
	20 cm/8"	NU.981.16	NU.482.16	NU.981.36	NU.482.36	NU.981.56	NU.482.56
	30 cm/11¾"	NU.981.20	NU.482.20	NU.981.40	NU.482.40	NU.981.60	NU.482.60

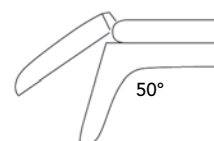
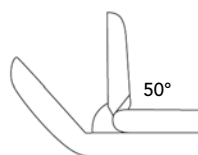





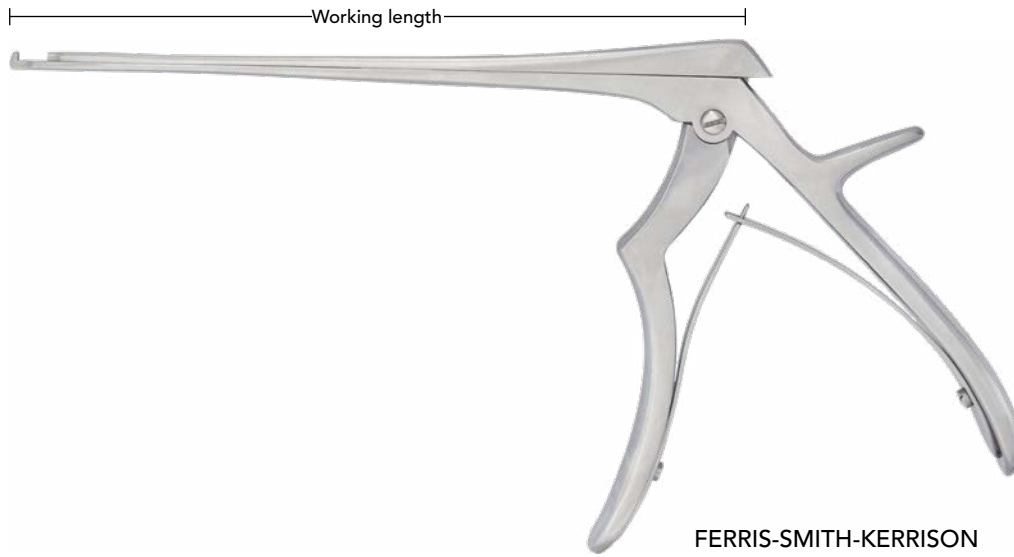

4 mm	Working length		
	18 cm/7"	NU.980.80	NU.484.80
	30 cm/11¾"	NU.981.81	NU.485.81







Working length			
	18 cm/7"	NU.982.80	NU.486.80
	30 cm/11¾"	NU.983.81	NU.487.81

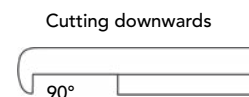
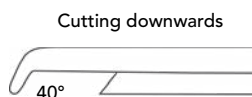
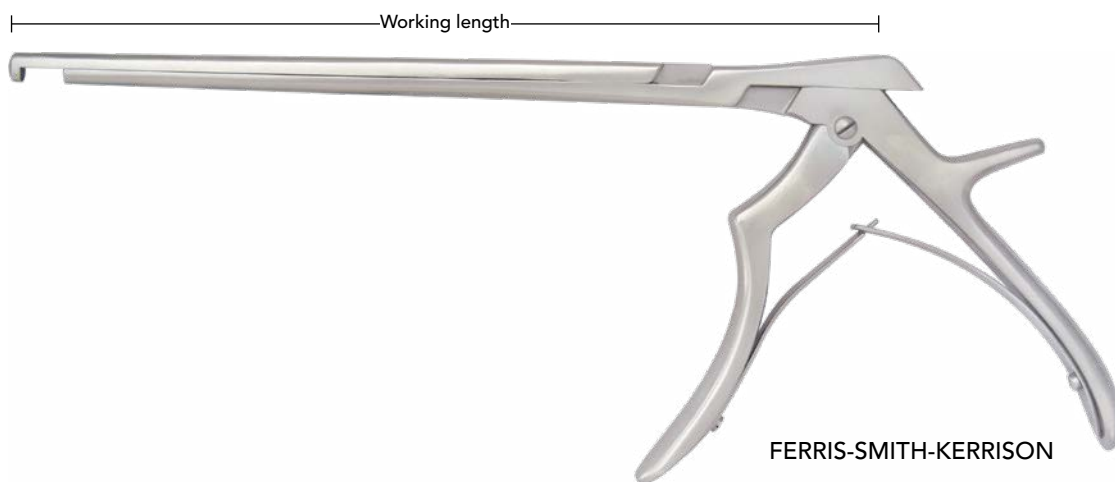

FERRIS-SMITH-KERRISON

		Cutting upwards 40°		Cutting upwards 90°	
	Working length	40°	40°	90°	90°
1 mm 	18 cm/7"	NU.978.01	NU.478.01	NU.978.02	NU.478.02
	20 cm/7¾"	NU.978.03	NU.478.03	NU.978.04	NU.478.04
	23 cm/9"	NU.978.05	NU.478.05	NU.978.06	NU.478.06
	28 cm/11"	NU.978.07	NU.478.07	NU.978.08	NU.478.08
2 mm 	18 cm/7"	NU.978.09	NU.478.09	NU.978.10	NU.478.10
	20 cm/7¾"	NU.978.11	NU.478.11	NU.978.12	NU.478.12
	23 cm/9"	NU.978.13	NU.478.13	NU.978.14	NU.478.14
	28 cm/11"	NU.978.15	NU.478.15	NU.978.16	NU.478.16
3 mm 	18 cm/7"	NU.978.17	NU.478.17	NU.978.18	NU.478.18
	20 cm/7¾"	NU.978.19	NU.478.19	NU.978.20	NU.478.20
	23 cm/9"	NU.978.21	NU.478.21	NU.978.22	NU.478.22
	28 cm/11"	NU.978.23	NU.478.23	NU.978.24	NU.478.24
4 mm 	18 cm/7"	NU.978.25	NU.478.25	NU.978.26	NU.978.26
	20 cm/7¾"	NU.978.27	NU.478.27	NU.978.28	NU.978.28
	23 cm/9"	NU.978.29	NU.478.29	NU.978.30	NU.978.30
	28 cm/11"	NU.978.31	NU.478.31	NU.978.32	NU.978.32
5 mm 	18 cm/7"	NU.978.33	NU.478.33	NU.978.34	NU.478.34
	20 cm/7¾"	NU.978.35	NU.478.35	NU.978.36	NU.478.36
	23 cm/9"	NU.978.37	NU.478.37	NU.978.38	NU.478.38
	28 cm/11"	NU.978.39	NU.478.39	NU.978.40	NU.478.40
6 mm 	18 cm/7"	NU.978.41	NU.478.41	NU.978.42	NU.478.42
	20 cm/7¾"	NU.978.43	NU.478.43	NU.978.44	NU.478.44
	23 cm/9"	NU.978.45	NU.478.45	NU.978.46	NU.478.46
	28 cm/11"	NU.978.47	NU.478.47	NU.978.48	NU.478.48



	Working length	40°	40°	90°	90°
1 mm 	18 cm/7"	NU.978.50	NU.478.50	NU.978.51	NU.478.51
	20 cm/7¾"	NU.978.52	NU.478.52	NU.978.53	NU.478.53
	23 cm/9"	NU.978.54	NU.478.54	NU.978.55	NU.478.55
2 mm 	18 cm/7"	NU.978.56	NU.478.56	NU.978.57	NU.478.57
	20 cm/7¾"	NU.978.58	NU.478.58	NU.978.59	NU.478.59
	23 cm/9"	NU.978.60	NU.478.60	NU.978.61	NU.478.61
3 mm 	18 cm/7"	NU.978.62	NU.478.62	NU.978.63	NU.478.63
	20 cm/7¾"	NU.978.64	NU.478.64	NU.978.65	NU.478.65
	23 cm/9"	NU.978.66	NU.478.66	NU.978.67	NU.478.67
4 mm 	18 cm/7"	NU.978.68	NU.478.68	NU.978.69	NU.478.69
	20 cm/7¾"	NU.978.70	NU.478.70	NU.978.71	NU.478.71
	23 cm/9"	NU.978.72	NU.478.72	NU.978.73	NU.478.73
5 mm 	18 cm/7"	NU.978.74	NU.478.64	NU.978.75	NU.478.75
	20 cm/7¾"	NU.978.76	NU.478.76	NU.978.77	NU.478.77
	23 cm/9"	NU.978.78	NU.478.78	NU.978.79	NU.478.79
6 mm 	18 cm/7"	NU.978.80	NU.478.80	NU.978.81	NU.478.81
	20 cm/7¾"	NU.978.82	NU.478.82	NU.978.83	NU.478.83
	23 cm/9"	NU.978.84	NU.478.84	NU.978.85	NU.478.85

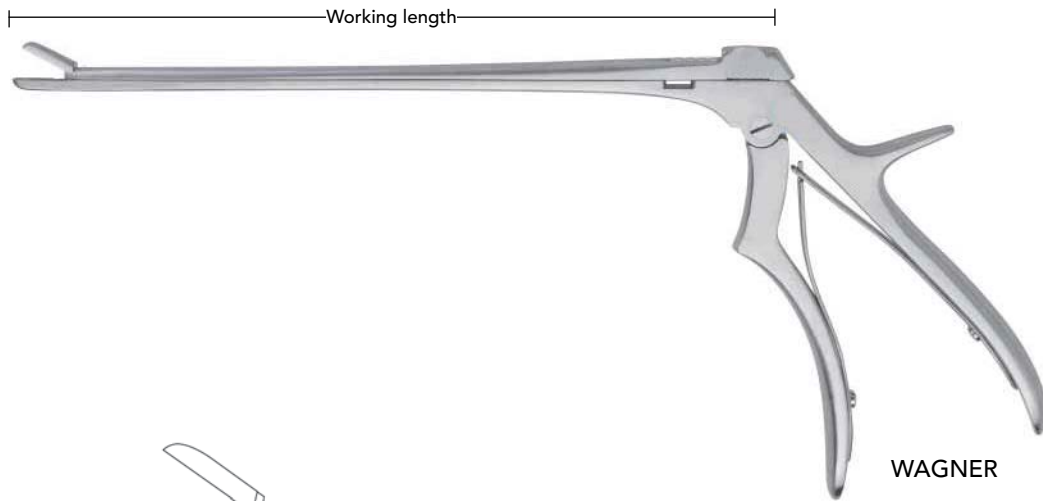

WAGNER

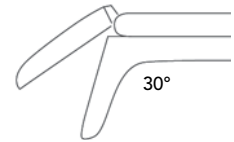
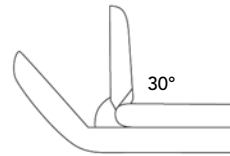
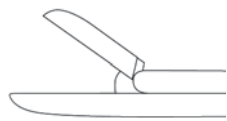

3 mm Working length
 20 cm/8" **NU.981.91** **NU.481.91**
 30 cm/11¾" **NU.981.94** **NU.481.94**

4 mm Working length
 20 cm/8" **NU.981.92** **NU.481.92** **NU.981.84** **NU.481.84** **NU.981.86** **NU.481.86**
 30 cm/11¾" **NU.981.95** **NU.481.95** **NU.981.85** **NU.481.85** **NU.981.87** **NU.481.87**

5 mm Working length
 15 cm/6" **NU.981.93** **NU.481.93**
 18 cm/7" **NU.981.96** **NU.481.96**

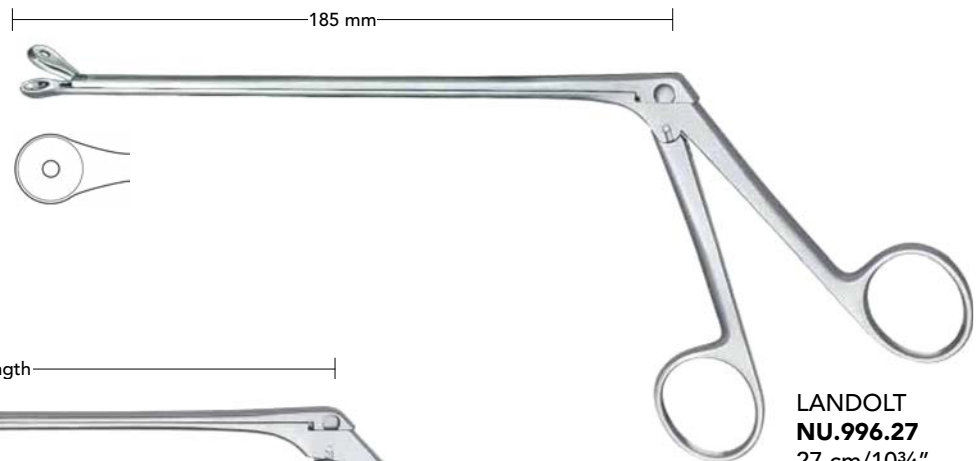

LANDOLT
NU.996.27
 27 cm/10¾"

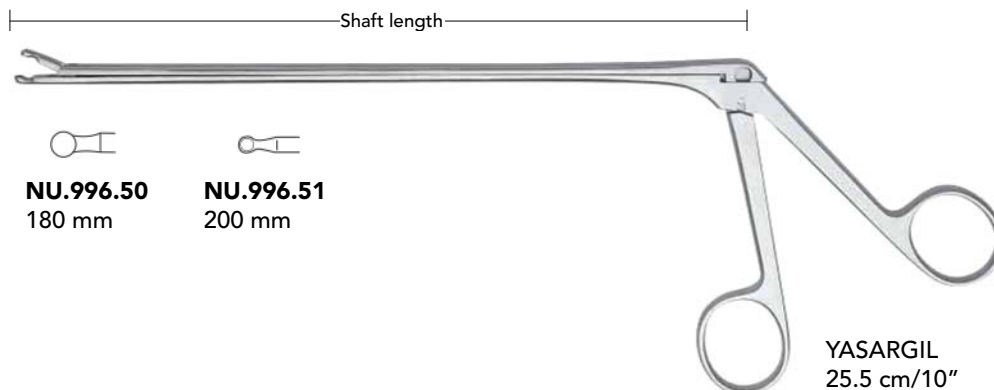

YASARGIL
 25.5 cm/10"

NU.996.50 180 mm **NU.996.51** 200 mm



Jaw spoon-shaped

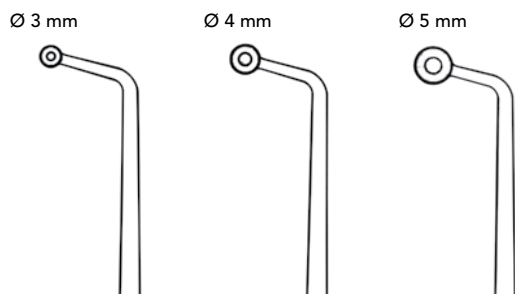

Jaw spoon-shaped

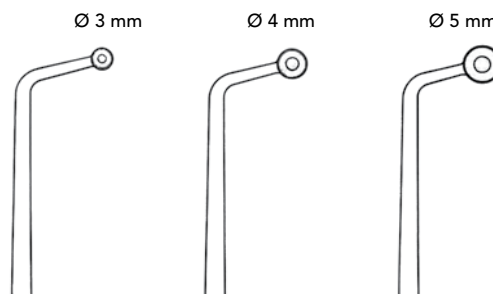

YASARGIL-SAMII

23 cm/9" **MT.852.01** **MT.852.02** **MT.852.03** **MT.853.01** **MT.853.02** **MT.853.03**

Jaw spoon-shaped

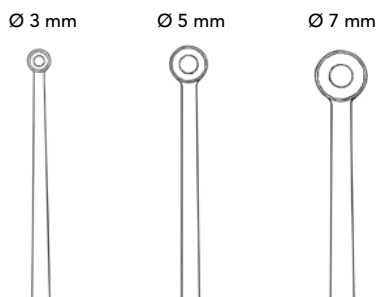

YASARGIL

22 cm/8¾" **MT.863.22** **MT.865.22** **MT.867.22**
 24 cm/9½" **MT.863.24** **MT.865.24** **MT.867.24**

Jaw flat, serrated

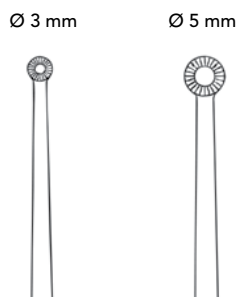

YASARGIL

20 cm/8" **MT.871.20** **MT.872.20**
 22 cm/8¾" **MT.871.22** **MT.872.22** **MT.873.22** **MT.875.22**

Curette jaw, toothed

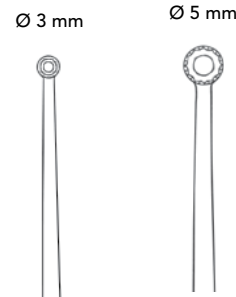

YASARGIL

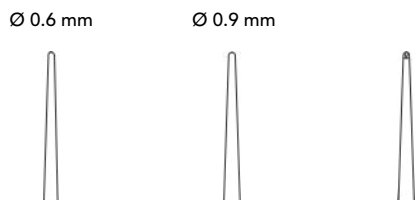

16 cm/6¼" **MT.856.16** **MT.859.16**
 18 cm/7" **MT.856.18** **MT.859.18** **MT.860.18**
 20 cm/8" **MT.856.20** **MT.859.20**
 22 cm/8¾" **MT.856.22** **MT.859.22**
 24 cm/9½" **MT.856.24** **MT.859.24**

Jaw flat, serrated

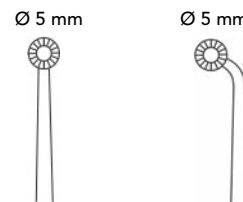

MT.890.20 **MT.891.20**



HUNT
20 cm/8"

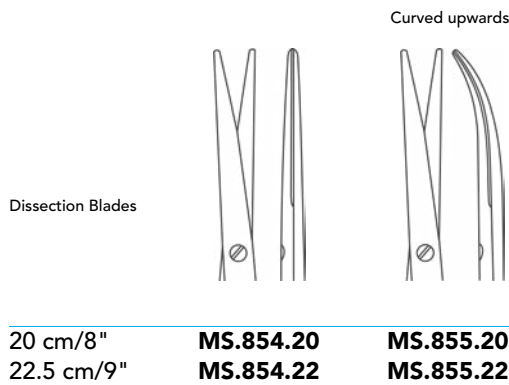
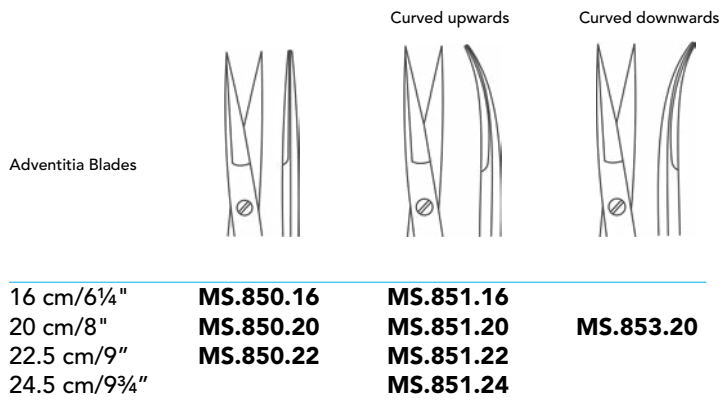
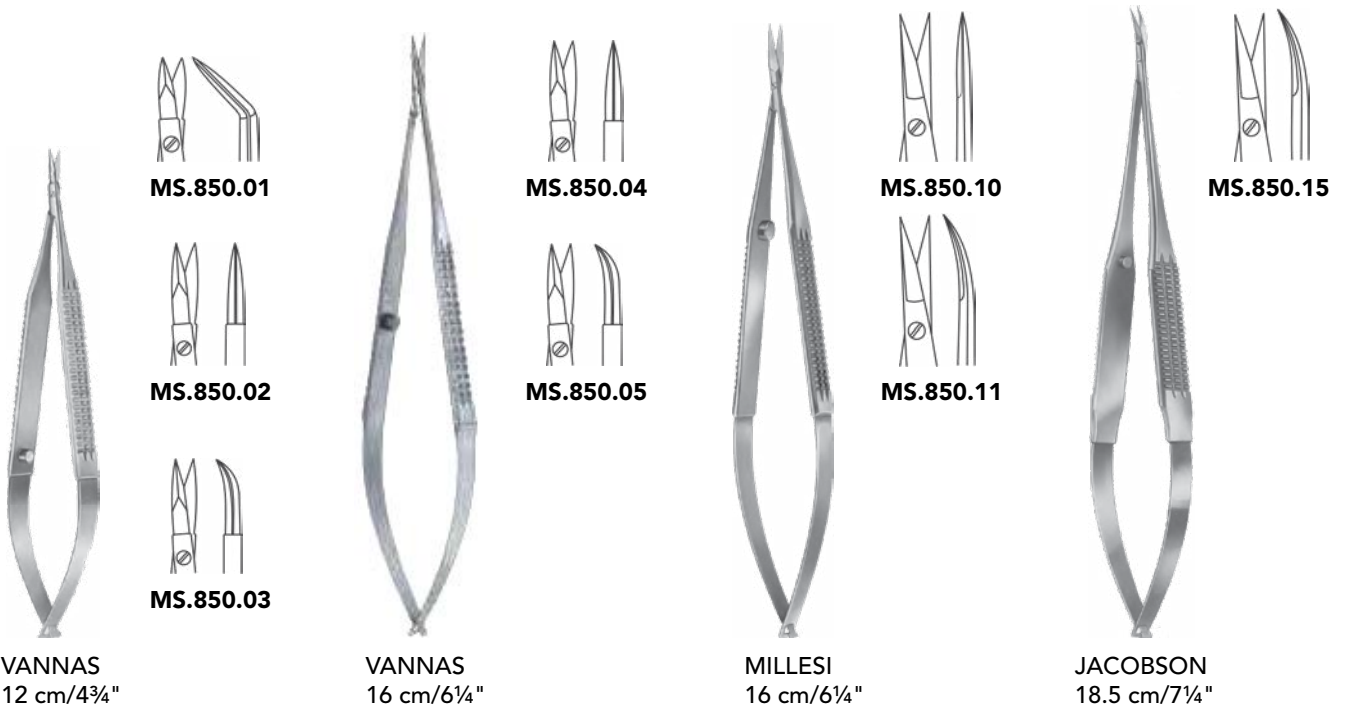



CASPAR
NU.850.60
11.5 cm/4½"

FAHLBUSCH
NU.850.50
16.5 cm/6½"

Micro Needle Holders

Micro Needle Holders



YASARGIL

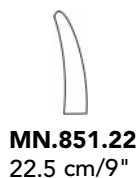
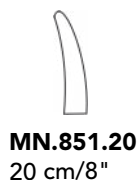
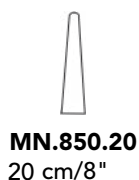

JACOBSON
18 cm/7"

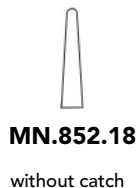

JACOBSON
18 cm/7"

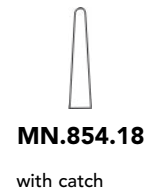

OP.546.02
Sadece matkap kolu
Brace only

HUDSON OP.546.00
Komple/Complete
V 502.01, V 502.02, V 500.03,
V 500.04, V 500.05, V 500.06,
V 500.07



HUDSON OP.546.01
Sadece uzatma parçası
Extension piece only



CUSHING OP.546.03
Ø 10 mm

CUSHING OP.546.04
Ø 15 mm

CUSHING OP.546.05
Ø 14 mm

McKENZIE OP.546.06
Ø 13 mm

HUDSON OP.546.07
Ø 14 mm

HUDSON OP.546.08
Ø 16 mm

ADSON OP.546.09
Ø 15 mm

HUDSON OP.546.10
Ø 22 mm

HUDSON OP.546.11
Ø 9 mm

OP.546.12
Ø 2 mm